

MC74HC4046A

Phase-Locked Loop

High-Performance Silicon-Gate CMOS

The MC74HC4046A is similar in function to the MC14046 Metal gate CMOS device. The device inputs are compatible with standard CMOS outputs; with pullup resistors, they are compatible with LSTTL outputs.

The HC4046A phase-locked loop contains three phase comparators, a voltage-controlled oscillator (VCO) and unity gain op-amp DEM_{OUT}. The comparators have two common signal inputs, COMP_{IN}, and SIG_{IN}. Input SIG_{IN} and COMP_{IN} can be used directly coupled to large voltage signals, or indirectly coupled (with a series capacitor to small voltage signals). The self-bias circuit adjusts small voltage signals in the linear region of the amplifier. Phase comparator 1 (an exclusive OR gate) provides a digital error signal PC1_{OUT} and maintains 90 degrees phase shift at the center frequency between SIG_{IN} and COMP_{IN} signals (both at 50% duty cycle). Phase comparator 2 (with leading-edge sensing logic) provides digital error signals PC2_{OUT} and PCP_{OUT} and maintains a 0 degree phase shift between SIG_{IN} and COMP_{IN} signals (duty cycle is immaterial). The linear VCO produces an output signal VCO_{OUT} whose frequency is determined by the voltage of input VCO_{IN} signal and the capacitor and resistors connected to pins C1A, C1B, R1 and R2. The unity gain op-amp output DEM_{OUT} with an external resistor is used where the VCO_{IN} signal is needed but no loading can be tolerated. The inhibit input, when high, disables the VCO and all op-amps to minimize standby power consumption.

Applications include FM and FSK modulation and demodulation, frequency synthesis and multiplication, frequency discrimination, tone decoding, data synchronization and conditioning, voltage-to-frequency conversion and motor speed control.

Features

- Output Drive Capability: 10 LSTTL Loads
- Low Power Consumption Characteristic of CMOS Devices
- Operating Speeds Similar to LSTTL
- Wide Operating Voltage Range: 3.0 to 6.0 V
- Low Input Current: 1.0 μ A Maximum (except SIG_{IN} and COMP_{IN})
- In Compliance with the Requirements Defined by JEDEC Standard No. 7A
- Low Quiescent Current: 80 μ A Maximum (VCO disabled)
- High Noise Immunity Characteristic of CMOS Devices
- Diode Protection on all Inputs
- Chip Complexity: 279 FETs or 70 Equivalent Gates
- Pb-Free Packages are Available*

*For additional information on our Pb-Free strategy and soldering details, please download the ON Semiconductor Soldering and Mounting Techniques Reference Manual, SOLDERRM/D.



ON Semiconductor®

<http://onsemi.com>

MARKING DIAGRAMS

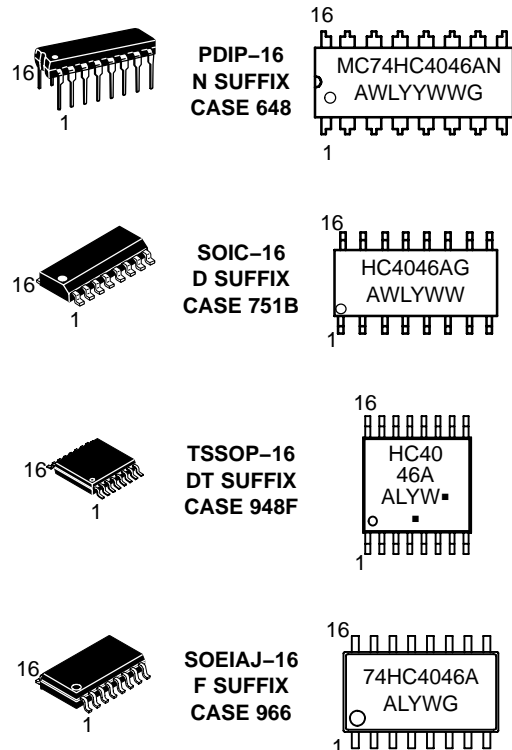

A = Assembly Location
L, WL = Wafer Lot
Y, YY = Year
W, WW = Work Week
G = Pb-Free Package
▪ = Pb-Free Package
(Note: Microdot may be in either location)

ORDERING INFORMATION

See detailed ordering and shipping information in the package dimensions section on page 5 of this data sheet.

MC74HC4046A

Pin No.	Symbol	Name and Function
1	PCP _{OUT}	Phase Comparator Pulse Output
2	PC1 _{OUT}	Phase Comparator 1 Output
3	COMP _{IN}	Comparator Input
4	VCO _{OUT}	VCO Output
5	INH	Inhibit Input
6	C1A	Capacitor C1 Connection A
7	C1B	Capacitor C1 Connection B
8	GND	Ground (0 V) V _{SS}
9	VCO _{IN}	VCO Input
10	DEM _{OUT}	Demodulator Output
11	R1	Resistor R1 Connection
12	R2	Resistor R2 Connection
13	PC2 _{OUT}	Phase Comparator 2 Output
14	SIG _{IN}	Signal Input
15	PC3 _{OUT}	Phase Comparator 3 Output
16	V _{CC}	Positive Supply Voltage

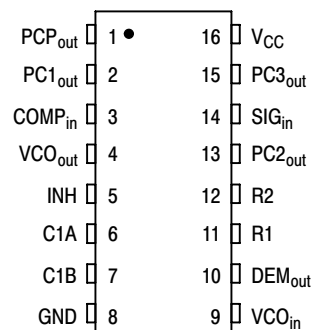

Figure 1. Pin Assignment

MAXIMUM RATINGS

Symbol	Parameter	Value	Unit
V _{CC}	DC Supply Voltage (Referenced to GND)	- 0.5 to + 7.0	V
V _{in}	DC Input Voltage (Referenced to GND)	- 1.5 to V _{CC} + 1.5	V
V _{out}	DC Output Voltage (Referenced to GND)	- 0.5 to V _{CC} + 0.5	V
I _{in}	DC Input Current, per Pin	± 20	mA
I _{out}	DC Output Current, per Pin	± 25	mA
I _{CC}	DC Supply Current, V _{CC} and GND Pins	± 50	mA
P _D	Power Dissipation in Still Air Plastic DIP† SOIC Package†	750 500	mW
T _{stg}	Storage Temperature	- 65 to + 150	°C
T _L	Lead Temperature, 1 mm from Case for 10 Seconds Plastic DIP and SOIC Package†	260	°C

This device contains protection circuitry to guard against damage due to high static voltages or electric fields. However, precautions must be taken to avoid applications of any voltage higher than maximum rated voltages to this high-impedance circuit. For proper operation, V_{in} and V_{out} should be constrained to the range GND ≤ (V_{in} or V_{out}) ≤ V_{CC}.

Unused inputs must always be tied to an appropriate logic voltage level (e.g., either GND or V_{CC}). Unused outputs must be left open.

Maximum ratings are those values beyond which device damage can occur. Maximum ratings applied to the device are individual stress limit values (not normal operating conditions) and are not valid simultaneously. If these limits are exceeded, device functional operation is not implied, damage may occur and reliability may be affected.

†Derating — Plastic DIP: - 10 mW/°C from 65° to 125°C

SOIC Package: - 7 mW/°C from 65° to 125°C

For high frequency or heavy load considerations, see Chapter 2 of the ON Semiconductor High-Speed CMOS Data Book (DL129/D).

RECOMMENDED OPERATING CONDITIONS

Symbol	Parameter	Min	Max	Unit	
V _{CC}	DC Supply Voltage (Referenced to GND)	3.0	6.0	V	
V _{CC}	DC Supply Voltage (Referenced to GND) NON-VCO	2.0	6.0	V	
V _{in} , V _{out}	DC Input Voltage, Output Voltage (Referenced to GND)	0	V _{CC}	V	
T _A	Operating Temperature, All Package Types	- 55	+ 125	°C	
t _r , t _f	Input Rise and Fall Time (Pin 5)	V _{CC} = 2.0 V V _{CC} = 4.5 V V _{CC} = 6.0 V	0 0 0	1000 500 400	ns

MC74HC4046A

[Phase Comparator Section]

DC ELECTRICAL CHARACTERISTICS (Voltages Referenced to GND)

Symbol	Parameter	Test Conditions	V _{CC} V	Guaranteed Limit			Unit
				- 55 to 25°C	≤ 85°C	≤ 125°C	
V _{IH}	Minimum High-Level Input Voltage DC Coupled SIG _{IN} , COMP _{IN}	V _{out} = 0.1 V or V _{CC} - 0.1 V I _{out} ≤ 20 μA	2.0	1.5	1.5	1.5	V
			4.5	3.15	3.15	3.15	
			6.0	4.2	4.2	4.2	
V _{IL}	Maximum Low-Level Input Voltage DC Coupled SIG _{IN} , COMP _{IN}	V _{out} = 0.1 V or V _{CC} - 0.1 V I _{out} ≤ 20 μA	2.0	0.5	0.5	0.5	V
			4.5	1.35	1.35	1.35	
			6.0	1.8	1.8	1.8	
V _{OH}	Minimum High-Level Output Voltage PCP _{OUT} , PCn _{OUT}	V _{in} = V _{IH} or V _{IL} I _{out} ≤ 20 μA	2.0	1.9	1.9	1.9	V
			4.5	4.4	4.4	4.4	
			6.0	5.9	5.9	5.9	
		V _{in} = V _{IH} or V _{IL} I _{out} ≤ 4.0 mA I _{out} ≤ 5.2 mA	4.5	3.98	3.84	3.7	
			6.0	5.48	5.34	5.2	
V _{OL}	Maximum Low-Level Output Voltage Qa-Qh PCP _{OUT} , PCn _{OUT}	V _{out} = 0.1 V or V _{CC} - 0.1 V I _{out} ≤ 20 μA	2.0	0.1	0.1	0.1	V
			4.5	0.1	0.1	0.1	
			6.0	0.1	0.1	0.1	
		V _{in} = V _{IH} or V _{IL} I _{out} ≤ 4.0 mA I _{out} ≤ 5.2 mA	4.5	0.26	0.33	0.4	
			6.0	0.26	0.33	0.4	
I _{in}	Maximum Input Leakage Current SIG _{IN} , COMP _{IN}	V _{in} = V _{CC} or GND	2.0	± 3.0	± 4.0	± 5.0	μA
			3.0	± 7.0	± 9.0	± 11.0	
			4.5	± 18.0	± 23.0	± 27.0	
			6.0	± 30.0	± 38.0	± 45.0	
I _{OZ}	Maximum Three-State Leakage Current PC2 _{OUT}	Output in High-Impedance State V _{in} = V _{IH} or V _{IL} V _{out} = V _{CC} or GND	6.0	± 0.5	± 5.0	± 10	μA
I _{CC}	Maximum Quiescent Supply Current (per Package) (VCO disabled) Pins 3, 5 and 14 at V _{CC} Pin 9 at GND; Input Leakage at Pins 3 and 14 to be excluded	V _{in} = V _{CC} or GND I _{out} = 0 μA	6.0	4.0	40	160	μA

NOTE: Information on typical parametric values can be found in Chapter 2 of the ON Semiconductor High-Speed CMOS Data Book (DL129/D).

[Phase Comparator Section]

AC ELECTRICAL CHARACTERISTICS (C_L = 50 pF, Input t_r = t_f = 6.0 ns)

Symbol	Parameter	V _{CC} V	Guaranteed Limit			Unit
			- 55 to 25°C	≤ 85°C	≤ 125°C	
t _{PLH} , t _{PHL}	Maximum Propagation Delay, SIG _{IN} /COMP _{IN} to PC1 _{OUT} (Figure 2)	2.0	175	220	265	ns
		4.5	35	44	53	
		6.0	30	37	45	
t _{PLH} , t _{PHL}	Maximum Propagation Delay, SIG _{IN} /COMP _{IN} to PCP _{OUT} (Figure 2)	2.0	340	425	510	ns
		4.5	68	85	102	
		6.0	58	72	87	
t _{PLH} , t _{PHL}	Maximum Propagation Delay, SIG _{IN} /COMP _{IN} to PC3 _{OUT} (Figure 2)	2.0	270	340	405	ns
		4.5	54	68	81	
		6.0	46	58	69	
t _{PLZ} , t _{PHZ}	Maximum Propagation Delay, SIG _{IN} /COMP _{IN} Output Disable Time to PC2 _{OUT} (Figures 3 and 4)	2.0	200	250	300	ns
		4.5	40	50	60	
		6.0	34	43	51	
t _{PZH} , t _{PZL}	Maximum Propagation Delay, SIG _{IN} /COMP _{IN} Output Enable Time to PC2 _{OUT} (Figures 3 and 4)	2.0	230	290	345	ns
		4.5	46	58	69	
		6.0	39	49	59	
t _{TLH} , t _{THL}	Maximum Output Transition Time (Figure 2)	2.0	75	95	110	ns
		4.5	15	19	22	
		6.0	13	16	19	

MC74HC4046A

[VCO Section]

DC ELECTRICAL CHARACTERISTICS (Voltages Referenced to GND)

Symbol	Parameter	Test Conditions	V _{CC} V	Guaranteed Limit						Unit
				- 55 to 25°C		≤ 85°C		≤ 125°C		
V _{IH}	Minimum High-Level Input Voltage INH	V _{out} = 0.1 V or V _{CC} - 0.1 V I _{out} ≤ 20 μA	3.0	2.1		2.1		2.1		V
			4.5	3.15		3.15		3.15		
			6.0	4.2		4.2		4.2		
V _{IL}	Maximum Low-Level Input Voltage INH	V _{out} = 0.1 V or V _{CC} - 0.1 V I _{out} ≤ 20 μA	3.0	0.90		0.9		0.9		V
			4.5	1.35		1.35		1.35		
			6.0	1.8		1.8		1.8		
V _{OH}	Minimum High-Level Output Voltage VCO _{OUT}	V _{in} = V _{IH} or V _{IL} I _{out} ≤ 20 μA	3.0	1.9		1.9		1.9		V
			4.5	4.4		4.4		4.4		
		6.0	5.9		5.9		5.9			
		4.5	V _{in} = V _{IH} or V _{IL} I _{out} ≤ 4.0 mA	3.98		3.84		3.7		
6.0	V _{in} = V _{IH} or V _{IL} I _{out} ≤ 5.2 mA			5.48		5.34		5.2		
		V _{OL}	Maximum Low-Level Output Voltage VCO _{OUT}	V _{out} = 0.1 V or V _{CC} - 0.1 V I _{out} ≤ 20 μA	3.0	0.1		0.1		0.1
4.5	0.1				0.1		0.1			
6.0	0.1			0.1		0.1				
4.5	V _{in} = V _{IH} or V _{IL} I _{out} ≤ 4.0 mA			0.26		0.33		0.4		
		6.0	V _{in} = V _{IH} or V _{IL} I _{out} ≤ 5.2 mA	0.26		0.33		0.4		
I _{in}	Maximum Input Leakage Current INH, VCO _{IN}			V _{in} = V _{CC} or GND	6.0	0.1		1.0		1.0
V _{VCO IN}	Operating Voltage Range at VCO _{IN} over the range specified for R1; For linearity see Fig. 15A, Parallel value of R1 and R2 should be > 2.7 kΩ	INH = V _{IL}	3.0 4.5 6.0	Min	Max	Min	Max	Min	Max	V
				0.1	1.0	0.1	1.0	0.1	1.0	
				0.1	2.5	0.1	2.5	0.1	2.5	
				0.1	4.0	0.1	4.0	0.1	4.0	
R1	Resistor Range		3.0	3.0	300	3.0	300	3.0	300	kΩ
			4.5	3.0	300	3.0	300	3.0	300	
			6.0	3.0	300	3.0	300	3.0	300	
R2	Resistor Range		3.0	3.0	300	3.0	300	3.0	300	kΩ
			4.5	3.0	300	3.0	300	3.0	300	
			6.0	3.0	300	3.0	300	3.0	300	
C1	Capacitor Range		3.0	40	No Limit					pF
			4.5	40						
			6.0	40						

[VCO Section]

AC ELECTRICAL CHARACTERISTICS (C_L = 50 pF, Input t_r = t_f = 6.0 ns)

Symbol	Parameter	V _{CC} V	Guaranteed Limit						Unit
			- 55 to 25°C		≤ 85°C		≤ 125°C		
			Min	Max	Min	Max	Min	Max	
Δf/T	Frequency Stability with Temperature Changes (Figure 14A, B, C)	3.0							%K
		4.5							
		6.0							
f _o	VCO Center Frequency (Duty Factor = 50%) (Figure 15A, B, C, D)	3.0	3					MHz	
		4.5	11						
		6.0	13						
ΔfVCO	VCO Frequency Linearity	3.0 4.5 6.0	See Figures 16A, B, C						%
∂ VCO	Duty Factor at VCO _{OUT}	3.0 4.5 6.0	Typical 50%						%

MC74HC4046A

[Demodulator Section]

DC ELECTRICAL CHARACTERISTICS

Symbol	Parameter	Test Conditions	V _{CC} V	Guaranteed Limit						Unit
				- 55 to 25°C		≤ 85°C		≤ 125°C		
				Min	Max	Min	Max	Min	Max	
RS	Resistor Range	At RS > 300 kΩ the Leakage Current can Influence V _{DEMOUT}	3.0 4.5 6.0	50 50 50	300 300 300					kΩ
V _{OFF}	Offset Voltage V _{COIN} to V _{DEMOUT}	V _i = V _{VCOIN} = 1/2 V _{CC} ; Values taken over RS Range.	3.0 4.5 6.0	See Figure 13						mV
RD	Dynamic Output Resistance at DEM _{OUT}	V _{DEMOUT} = 1/2 V _{CC}	3.0 4.5 6.0	Typical 25 Ω						Ω

ORDERING INFORMATION

Device	Package	Shipping [†]
MC74HC4046AN	PDIP-16	2000 Units / Box
MC74HC4046ANG	PDIP-16 (Pb-Free)	2000 Units / Box
MC74HC4046AD	SOIC-16	48 Units / Rail
MC74HC4046ADG	SOIC-16 (Pb-Free)	48 Units / Rail
MC74HC4046ADR2	SOIC-16	2500 Units / Reel
MC74HC4046ADR2G	SOIC-16 (Pb-Free)	2500 Units / Reel
MC74HC4046ADT	TSSOP-16*	96 Units / Rail
MC74HC4046ADTG	TSSOP-16*	96 Units / Rail
MC74HC4046ADTR2	TSSOP-16*	2500 Units / Reel
MC74HC4046ADTR2G	TSSOP-16*	2500 Units / Reel
MC74HC4046AF	SOEIAJ-16	50 Units / Rail
MC74HC4046AFG	SOEIAJ-16 (Pb-Free)	50 Units / Rail
MC74HC4046AFEL	SOEIAJ-16	2000 Units / Reel
MC74HC4046AFELG	SOEIAJ-16 (Pb-Free)	2000 Units / Reel

[†]For information on tape and reel specifications, including part orientation and tape sizes, please refer to our Tape and Reel Packaging Specifications Brochure, BRD8011/D.

*This package is inherently Pb-Free.

MC74HC4046A

SWITCHING WAVEFORMS

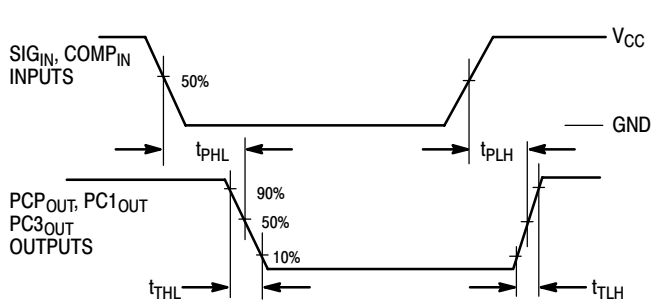

Figure 2.

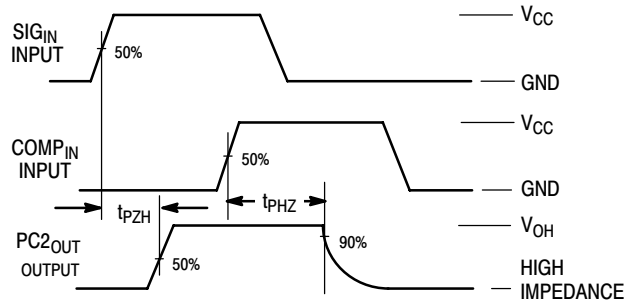

Figure 3.

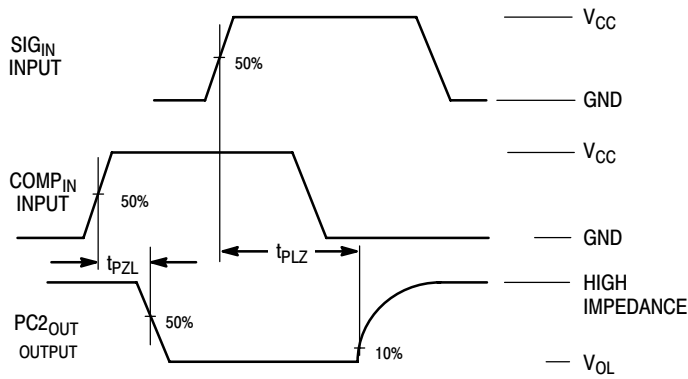
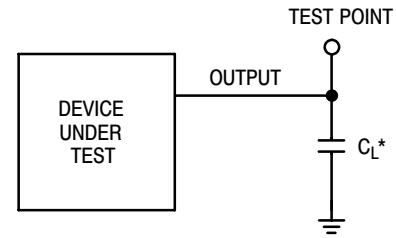

Figure 4.



*INCLUDES ALL PROBE AND JIG CAPACITANCE

Figure 5. Test Circuit

DETAILED CIRCUIT DESCRIPTION

Voltage Controlled Oscillator/Demodulator Output

The VCO requires two or three external components to operate. These are R1, R2, C1. Resistor R1 and Capacitor C1 are selected to determine the center frequency of the VCO (see typical performance curves Figure 15). R2 can be used to set the offset frequency with 0 volts at VCO input. For example, if R2 is decreased, the offset frequency is increased. If R2 is omitted the VCO range is from 0 Hz. The effect of R2 is shown in Figure 25, typical performance curves. By increasing the value of R2 the lock range of the PLL is increased and the gain (volts/Hz) is decreased. Thus, for a narrow lock range, large swings on the VCO input will cause less frequency variation.

Internally, the resistors set a current in a current mirror, as shown in Figure 6. The mirrored current drives one side of the capacitor. Once the voltage across the capacitor charges

up to V_{ref} of the comparators, the oscillator logic flips the capacitor which causes the mirror to charge the opposite side of the capacitor. The output from the internal logic is then taken to VCO output (Pin 4).

The input to the VCO is a very high impedance CMOS input and thus will not load down the loop filter, easing the filters design. In order to make signals at the VCO input accessible without degrading the loop performance, the VCO input voltage is buffered through a unity gain Op-amp to Demod Output. This Op-amp can drive loads of 50K ohms or more and provides no loading effects to the VCO input voltage (see Figure 13).

An inhibit input is provided to allow disabling of the VCO and all Op-amps (see Figure 6). This is useful if the internal VCO is not being used. A logic high on inhibit disables the VCO and all Op-amps, minimizing standby power consumption.

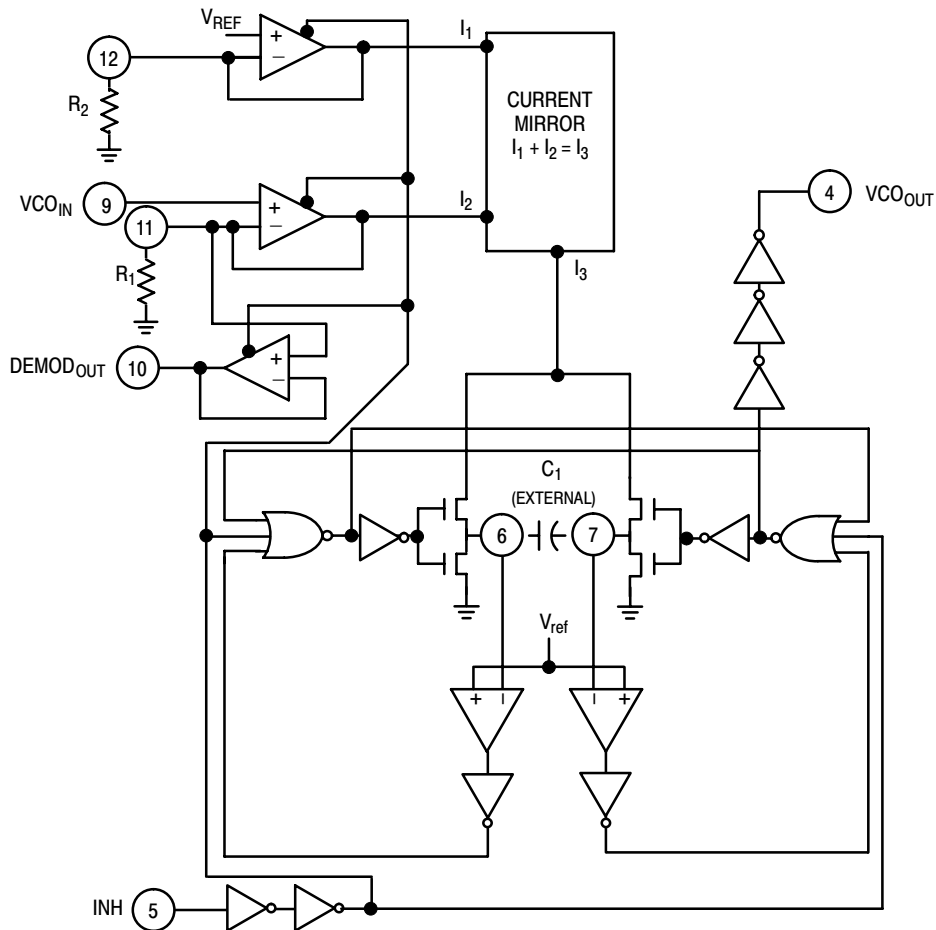

Figure 6. Logic Diagram for VCO

The output of the VCO is a standard high speed CMOS output with an equivalent LS-TTL fan out of 10. The VCO output is approximately a square wave. This output can either directly feed the $COMP_{IN}$ of the phase comparators or

feed external prescalers (counters) to enable frequency synthesis.

Phase Comparators

All three phase comparators have two inputs, SIG_{IN} and COMP_{IN}. The SIG_{IN} and COMP_{IN} have a special DC bias network that enables AC coupling of input signals. If the signals are not AC coupled, standard 74HC input levels are required. Both input structures are shown in Figure 7. The

outputs of these comparators are essentially standard 74HC outputs (comparator 2 is TRI-STATEABLE). In normal operation V_{CC} and ground voltage levels are fed to the loop filter. This differs from some phase detectors which supply a current to the loop filter and should be considered in the design. (The MC14046 also provides a voltage).

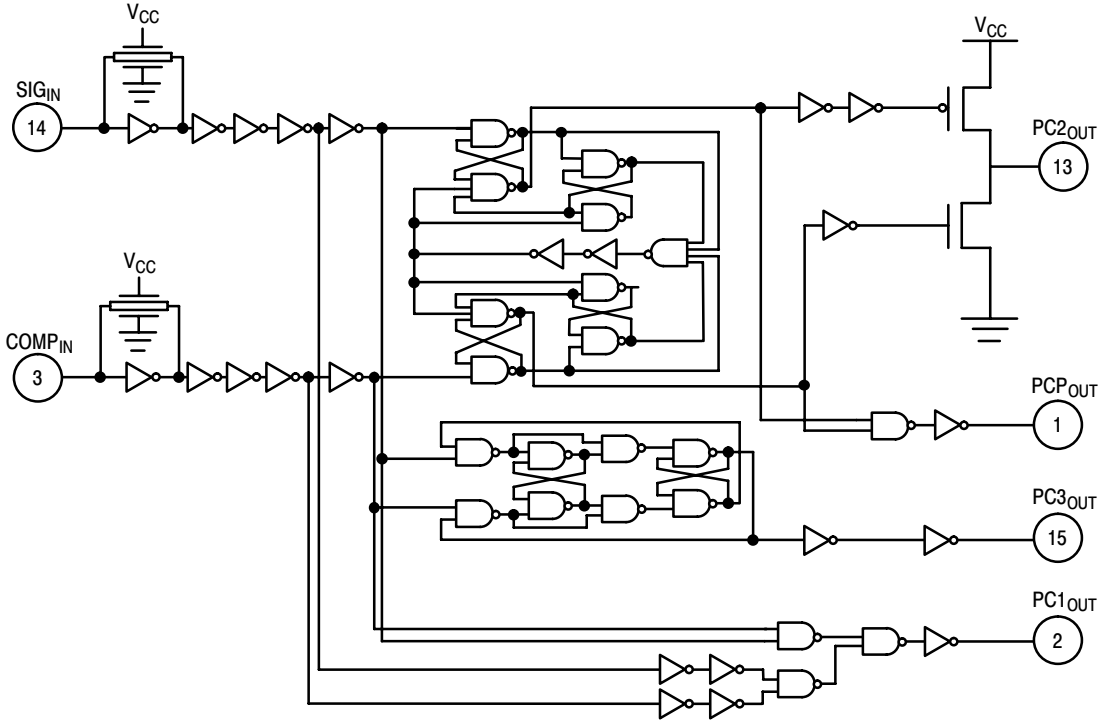

Figure 7. Logic Diagram for Phase Comparators

Phase Comparator 1

This comparator is a simple XOR gate similar to the 74HC86. Its operation is similar to an overdriven balanced modulator. To maximize lock range the input frequencies must have a 50% duty cycle. Typical input and output waveforms are shown in Figure 8. The output of the phase detector feeds the loop filter which averages the output voltage. The frequency range upon which the PLL will lock onto if initially out of lock is defined as the capture range. The capture range for phase detector 1 is dependent on the loop filter design. The capture range can be as large as the lock range, which is equal to the VCO frequency range.

To see how the detector operates, refer to Figure 8. When two square wave signals are applied to this comparator, an output waveform (whose duty cycle is dependent on the phase difference between the two signals) results. As the phase difference increases, the output duty cycle increases and the voltage after the loop filter increases. In order to achieve lock when the PLL input frequency increases, the VCO input voltage must increase and the phase difference between COMP_{IN} and SIG_{IN} will increase. At an input frequency equal to f_{min}, the VCO input is at 0 V. This requires the phase detector output to be grounded; hence, the

two input signals must be in phase. When the input frequency is f_{max}, the VCO input must be V_{CC} and the phase detector inputs must be 180 degrees out of phase.

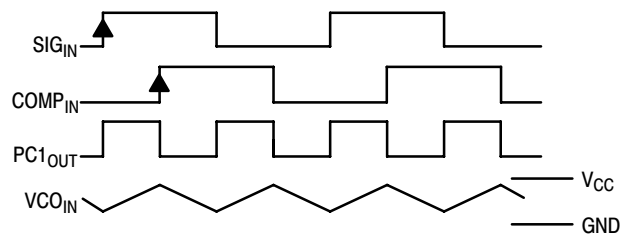

Figure 8. Typical Waveforms for PLL Using Phase Comparator 1

The XOR is more susceptible to locking onto harmonics of the SIG_{IN} than the digital phase detector 2. For instance, a signal 2 times the VCO frequency results in the same output duty cycle as a signal equal to the VCO frequency. The difference is that the output frequency of the 2f example is twice that of the other example. The loop filter and VCO range should be designed to prevent locking on to harmonics.

Phase Comparator 2

This detector is a digital memory network. It consists of four flip-flops and some gating logic, a three state output and a phase pulse output as shown in Figure 6. This comparator acts only on the positive edges of the input signals and is independent of duty cycle.

Phase comparator 2 operates in such a way as to force the PLL into lock with 0 phase difference between the VCO output and the signal input positive waveform edges. Figure 8 shows some typical loop waveforms. First assume that SIG_{IN} is leading the COMP_{IN}. This means that the VCO's frequency must be increased to bring its leading edge into proper phase alignment. Thus the phase detector 2 output is set high. This will cause the loop filter to charge up the VCO input, increasing the VCO frequency. Once the leading edge of the COMP_{IN} is detected, the output goes TRI-STATE holding the VCO input at the loop filter voltage. If the VCO still lags the SIG_{IN} then the phase detector will again charge up the VCO input for the time between the leading edges of both waveforms.

If the VCO leads the SIG_{IN} then when the leading edge of the VCO is seen; the output of the phase comparator goes low. This discharges the loop filter until the leading edge of the SIG_{IN} is detected at which time the output disables itself again. This has the effect of slowing down the VCO to again make the rising edges of both waveforms coincidental.

When the PLL is out of lock, the VCO will be running either slower or faster than the SIG_{IN}. If it is running slower the phase detector will see more SIG_{IN} rising edges and so the output of the phase comparator will be high a majority of the time, raising the VCO's frequency. Conversely, if the VCO is running faster than the SIG_{IN}, the output of the detector will be low most of the time and the VCO's output frequency will be decreased.

As one can see, when the PLL is locked, the output of phase comparator 2 will be disabled except for minor corrections at the leading edge of the waveforms. When PC₂ is TRI-STATE, the PCP output is high. This output can be used to determine when the PLL is in the locked condition.

This detector has several interesting characteristics. Over the entire VCO frequency range there is no phase difference between the COMP_{IN} and the SIG_{IN}. The lock range of the PLL is the same as the capture range. Minimal power was consumed in the loop filter since in lock the detector output will stay low, forcing the VCO to f_{min}.

Phase comparator 2 is more susceptible to noise, causing the PLL to unlock. If a noise pulse is seen on the SIG_{IN}, the comparator treats it as another positive edge of the SIG_{IN}

and will cause the output to go high until the VCO leading edge is seen, potentially for an entire SIG_{IN} period. This would cause the VCO to speed up during that time. When using PC₁, the output of that phase detector would be disturbed for only the short duration of the noise spike and would cause less upset.

Phase Comparator 3

This is a positive edge-triggered sequential phase detector using an RS flip-flop as shown in Figure 7. When the PLL is using this comparator, the loop is controlled by positive signal transitions and the duty factors of SIG_{IN} and COMP_{IN} are not important. It has some similar characteristics to the edge sensitive comparator. To see how this detector works, assume input pulses are applied to the SIG_{IN} and COMP_{IN}'s as shown in Figure 10. When the SIG_{IN} leads the COMP_{IN}, the flop is set. This will charge the loop filter and cause the VCO to speed up, bringing the comparator into phase with the SIG_{IN}. The phase angle between SIG_{IN} and COMP_{IN} varies from 0° to 360° and is 180° at f₀. The voltage swing for PC₃ is greater than for PC₂ but consequently has more ripple in the signal to the VCO. When no SIG_{IN} is present the VCO will be forced to f_{max} as opposed to f_{min} when PC₂ is used.

The operating characteristics of all three phase comparators should be compared to the requirements of the system design and the appropriate one should be used.

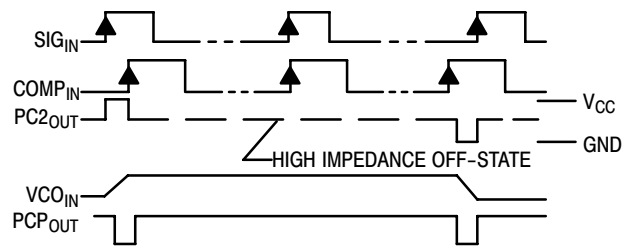

Figure 9. Typical Waveforms for PLL Using Phase Comparator 2

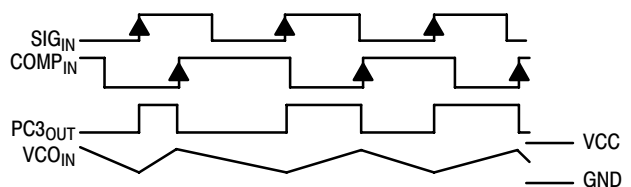

Figure 10. Typical Waveform for PLL Using Phase Comparator 3

MC74HC4046A

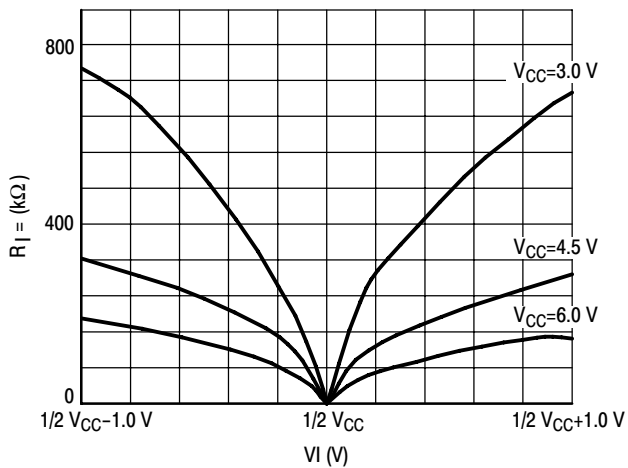

Figure 11. Input Resistance at SIG_{IN}, COMP_{IN} with $\Delta V_I = 1.0 \text{ V}$ at Self-Bias Point

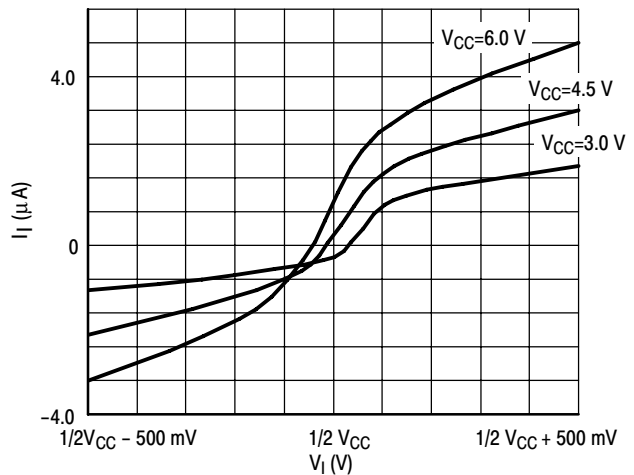

Figure 12. Input Current at SIG_{IN}, COMP_{IN} with $\Delta V_I = 500 \text{ mV}$ at Self-Bias Point

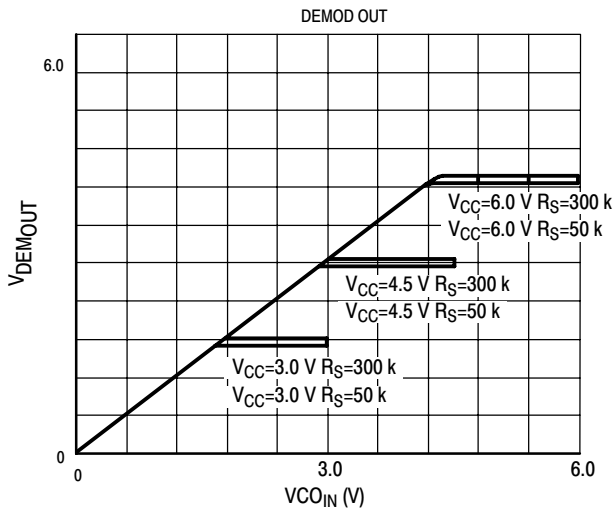

Figure 13. Offset Voltage at Demodulator Output as a Function of V_{CO_IN} and R_S

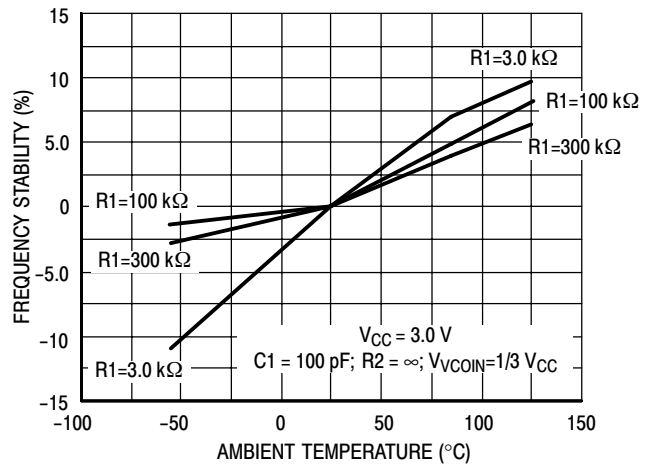

Figure 13A. Frequency Stability versus Ambient Temperature: $V_{CC} = 3.0 \text{ V}$

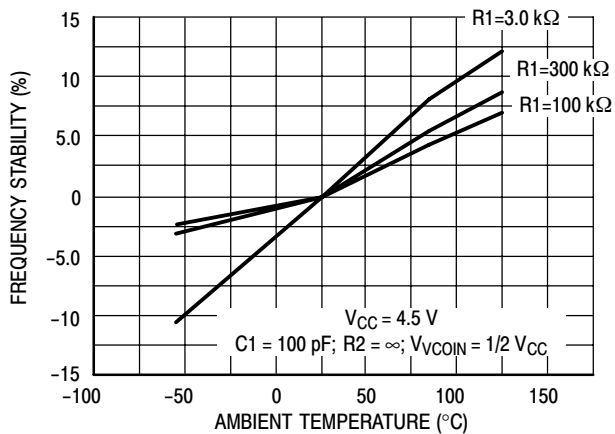

Figure 13B. Frequency Stability versus Ambient Temperature: $V_{CC} = 4.5 \text{ V}$

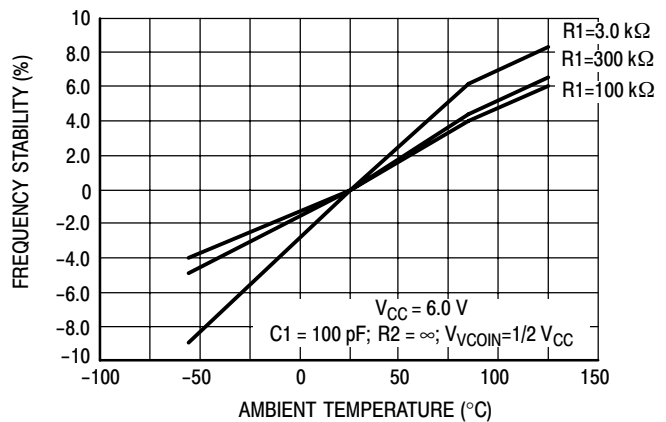

Figure 13C. Frequency Stability versus Ambient Temperature: $V_{CC} = 6.0 \text{ V}$

MC74HC4046A

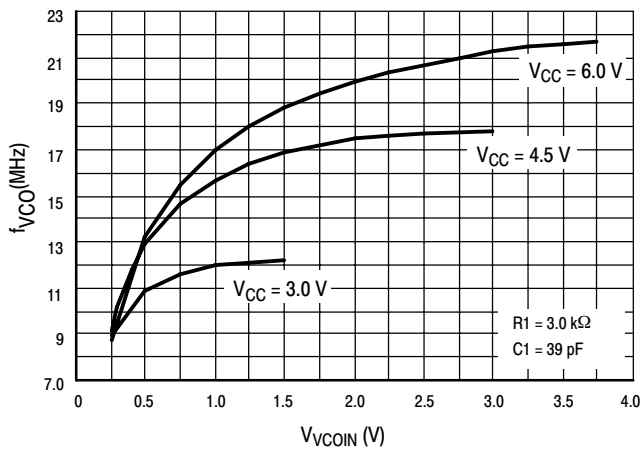

Figure 14A. VCO Frequency (f_{VCO}) as a Function of the VCO Input Voltage (V_{VCOIN})

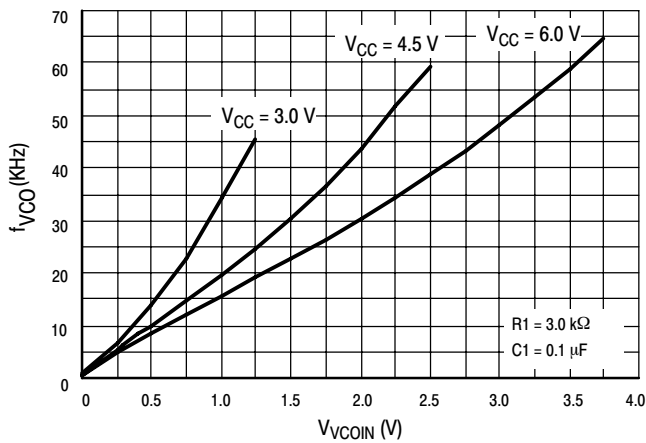

Figure 14B. VCO Frequency (f_{VCO}) as a Function of the VCO Input Voltage (V_{VCOIN})

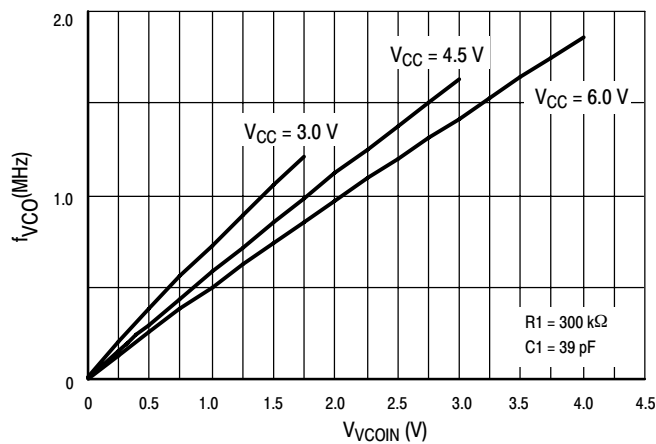

Figure 14C. VCO Frequency (f_{VCO}) as a Function of the VCO Input Voltage (V_{VCOIN})

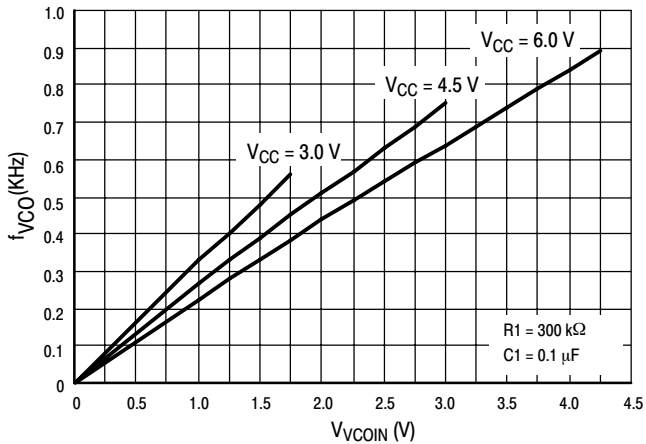

Figure 14D. VCO Frequency (f_{VCO}) as a Function of the VCO Input Voltage (V_{VCOIN})

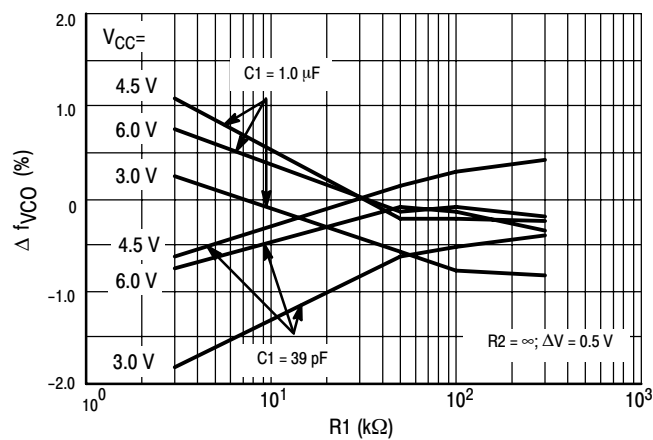

Figure 15A. Frequency Linearity versus R_1 , C_1 and V_{CC}

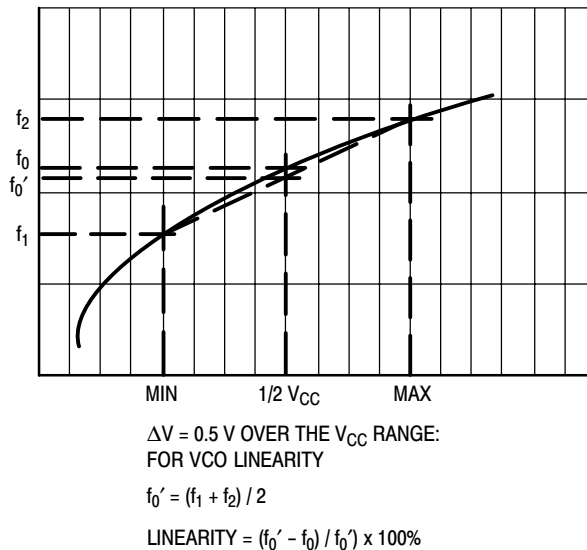

Figure 15B. Definition of VCO Frequency Linearity

MC74HC4046A

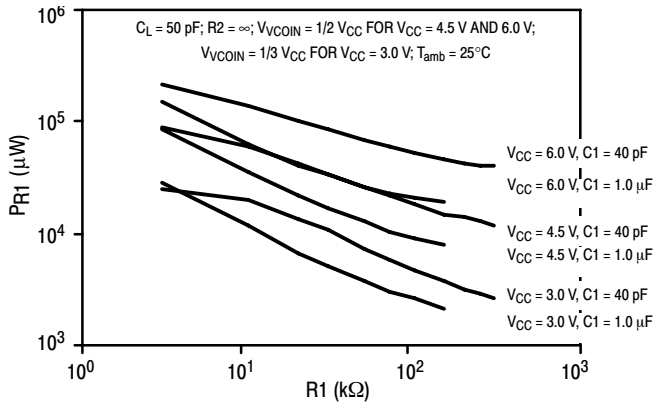

Figure 16. Power Dissipation versus R1

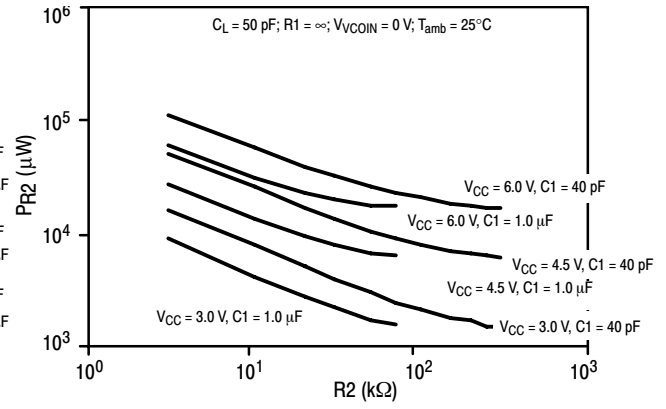

Figure 17. Power Dissipation versus R2

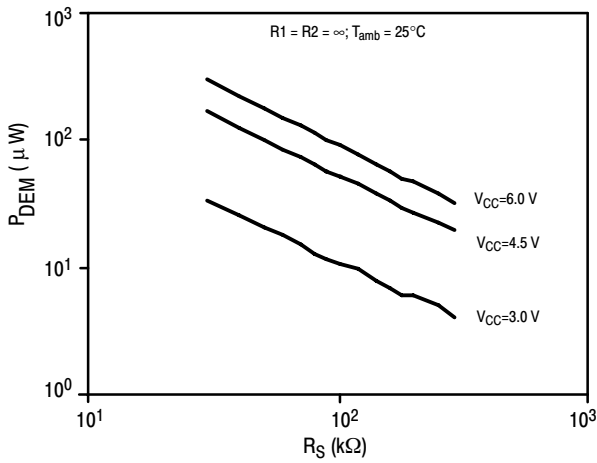

Figure 18. DC Power Dissipation of Demodulator versus RS

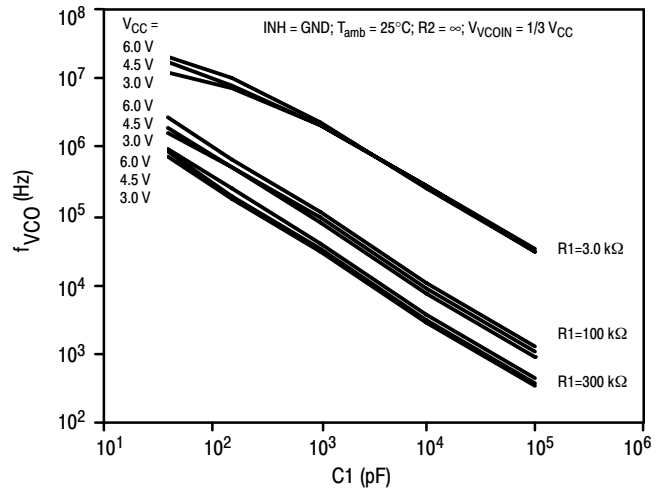

Figure 19. VCO Center Frequency versus C1

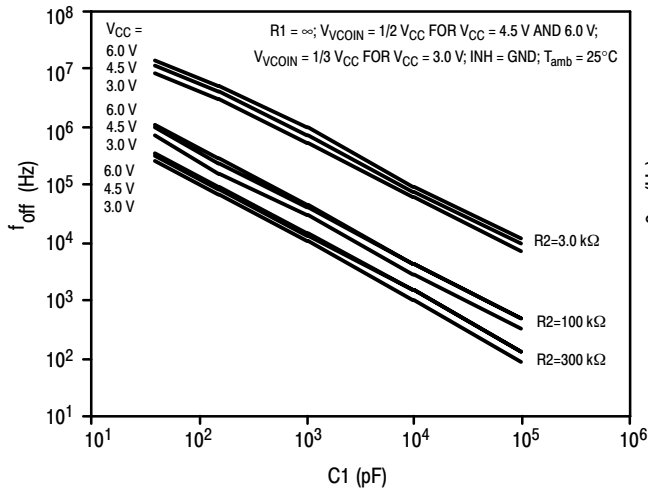

Figure 20. Frequency Offset versus C1

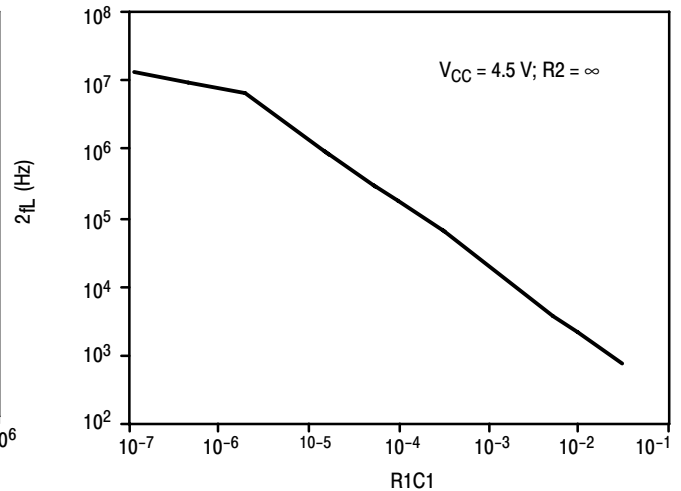

Figure 21. Typical Frequency Lock Range ($2f_L$) versus R_1C_1

MC74HC4046A

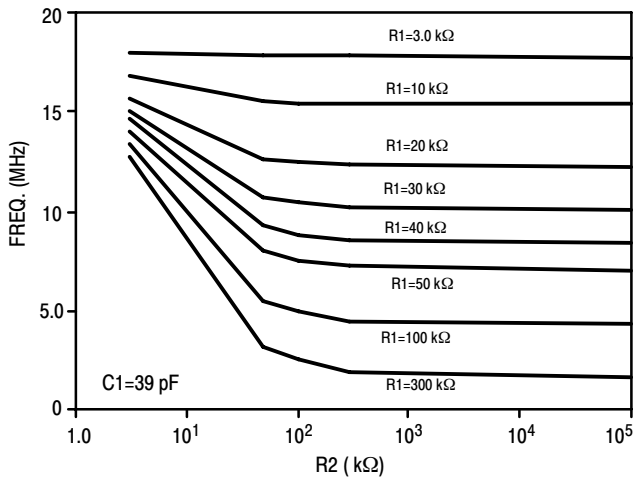

Figure 22. R2 versus f_{max}

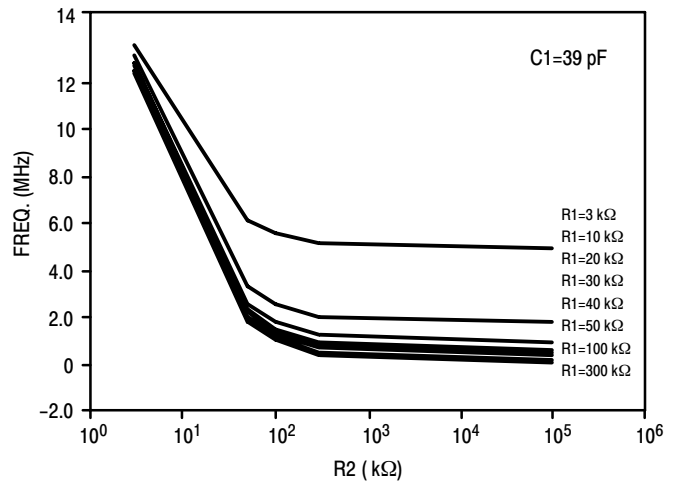

Figure 23. R2 versus f_{min}

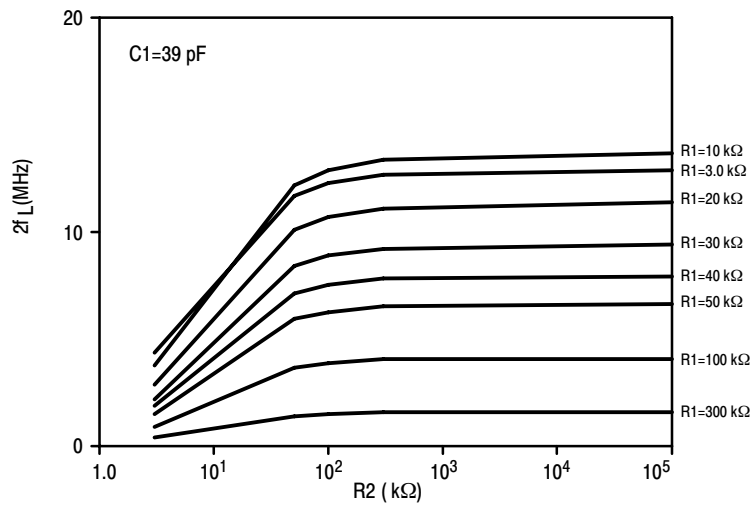

Figure 24. R2 versus Frequency Lock Range ($2f_L$)

MC74HC4046A

APPLICATION INFORMATION

The following information is a guide for approximate values of R1, R2, and C1. Figures 20, 21, and 22 should be used as references as indicated below, also the values of R1, R2, and C1 should not violate the Maximum values indicated in the DC ELECTRICAL CHARACTERISTICS tables.

Phase Comparator 1		Phase Comparator 2		Phase Comparator 3	
$R_2 = \infty$	$R_2 \neq \infty$	$R_2 = \infty$	$R_2 \neq \infty$	$R_2 = \infty$	$R_2 \neq \infty$
<ul style="list-style-type: none"> Given f_0 Use f_0 with Figure 19 to determine R1 and C1. (see Figure 24 for characteristics of the VCO operation) 	<ul style="list-style-type: none"> Given f_0 and f_L Calculate f_{min} $f_{min} = f_0 - f_L$ Determine values of C1 and R2 from Figure 21. Determine R1-C1 from Figure 22. Calculate value of R1 from the value of C1 and the product of R1C1 from Figure 22. (see Figure 25 for characteristics of the VCO operation) 	<ul style="list-style-type: none"> Given f_{max} and f_0 Determine the value of R1 and C1 using Figure 20 and use Figure 22 to obtain $2f_L$ and then use this to calculate f_{min}. 	<ul style="list-style-type: none"> Given f_0 and f_L Calculate f_{min} $f_{min} = f_0 - f_L$ Determine values of C1 and R2 from Figure 21. Determine R1-C1 from Figure 22. Calculate value of R1 from the value of C1 and the product of R1C1 from Figure 22. (see Figure 25 for characteristics of the VCO operation) 	<ul style="list-style-type: none"> Given f_{max} and f_0 Determine the value of R1 and C1 using Figure 20 and Figure 22 to obtain $2f_L$ and then use this to calculate f_{min}. 	<ul style="list-style-type: none"> Given f_0 and f_L Calculate f_{min}: $f_{min} = f_0 - f_L$ Determine values of C1 and R2 from Figure 21. Determine R1-C1 from Figure 22. Calculate value of R1 from the value of C1 and the product of R1C1 from Figure 22. (see Figure 25 for characteristics of the VCO operation)

MC74HC4046A

PACKAGE DIMENSIONS

PDIP-16
N SUFFIX
CASE 648-08
ISSUE T

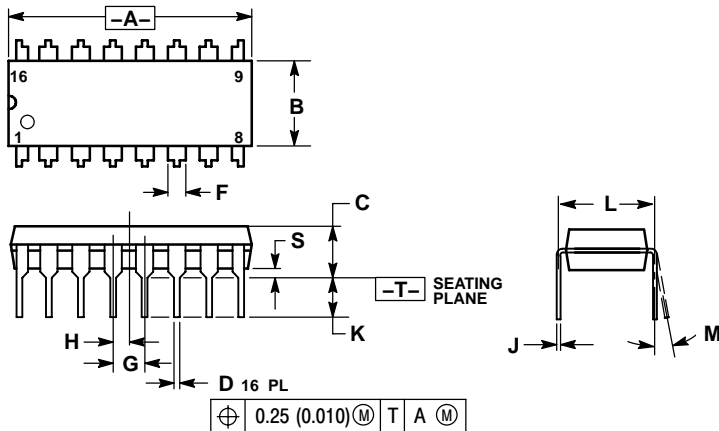

- NOTES:
1. DIMENSIONING AND TOLERANCING PER ANSI Y14.5M, 1982.
 2. CONTROLLING DIMENSION: INCH.
 3. DIMENSION L TO CENTER OF LEADS WHEN FORMED PARALLEL.
 4. DIMENSION B DOES NOT INCLUDE MOLD FLASH.
 5. ROUNDED CORNERS OPTIONAL.

DIM	INCHES		MILLIMETERS	
	MIN	MAX	MIN	MAX
A	0.740	0.770	18.80	19.55
B	0.250	0.270	6.35	6.85
C	0.145	0.175	3.69	4.44
D	0.015	0.021	0.39	0.53
F	0.040	0.70	1.02	1.77
G	0.100 BSC		2.54 BSC	
H	0.050 BSC		1.27 BSC	
J	0.008	0.015	0.21	0.38
K	0.110	0.130	2.80	3.30
L	0.295	0.305	7.50	7.74
M	0°		10°	
S	0.020	0.040	0.51	1.01

SOIC-16
D SUFFIX
CASE 751B-05
ISSUE J

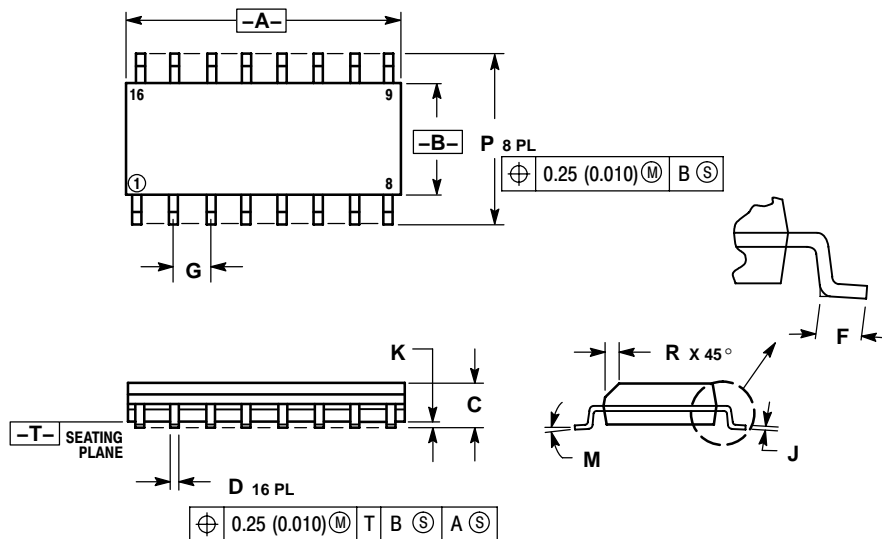

- NOTES:
1. DIMENSIONING AND TOLERANCING PER ANSI Y14.5M, 1982.
 2. CONTROLLING DIMENSION: MILLIMETER.
 3. DIMENSIONS A AND B DO NOT INCLUDE MOLD PROTRUSION.
 4. MAXIMUM MOLD PROTRUSION 0.15 (0.006) PER SIDE.
 5. DIMENSION D DOES NOT INCLUDE DAMBAR PROTRUSION. ALLOWABLE DAMBAR PROTRUSION SHALL BE 0.127 (0.005) TOTAL IN EXCESS OF THE D DIMENSION AT MAXIMUM MATERIAL CONDITION.

DIM	MILLIMETERS		INCHES	
	MIN	MAX	MIN	MAX
A	9.80	10.00	0.386	0.393
B	3.80	4.00	0.150	0.157
C	1.35	1.75	0.054	0.068
D	0.35	0.49	0.014	0.019
F	0.40	1.25	0.016	0.049
G	1.27 BSC		0.050 BSC	
J	0.19	0.25	0.008	0.009
K	0.10	0.25	0.004	0.009
M	0°		7°	
P	5.80	6.20	0.229	0.244
R	0.25	0.50	0.010	0.019

MC74HC4046A

PACKAGE DIMENSIONS

TSSOP-16
DT SUFFIX
CASE 948F-01
ISSUE A

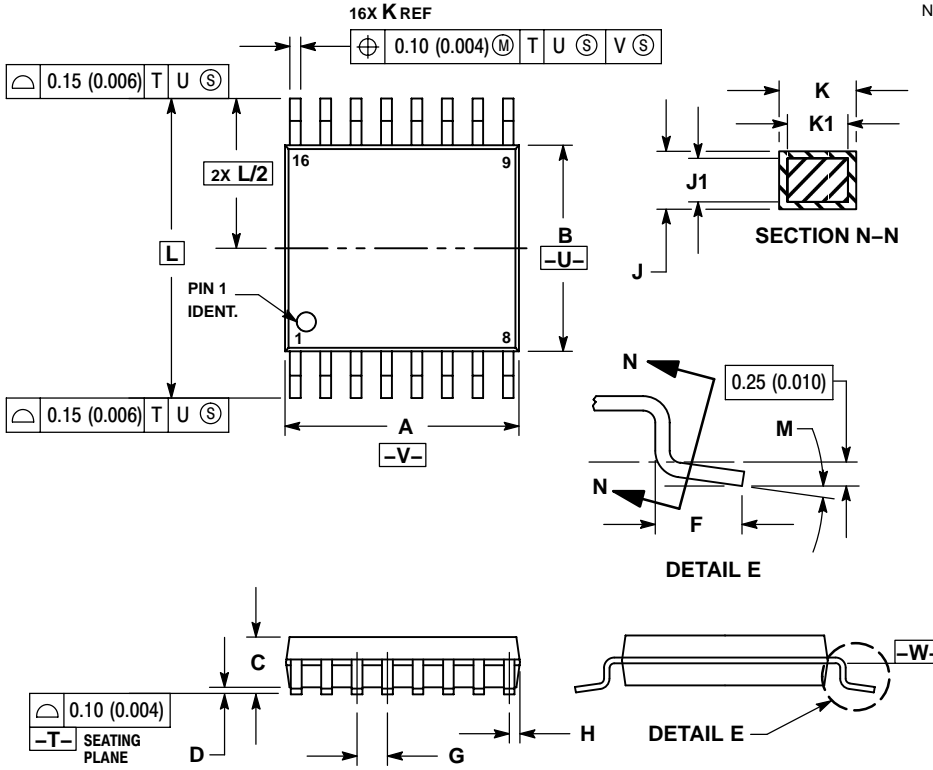

NOTES:

1. DIMENSIONING AND TOLERANCING PER ANSI Y14.5M, 1982.
2. CONTROLLING DIMENSION: MILLIMETER.
3. DIMENSION A DOES NOT INCLUDE MOLD FLASH, PROTRUSIONS OR GATE BURRS. MOLD FLASH OR GATE BURRS SHALL NOT EXCEED 0.15 (0.006) PER SIDE.
4. DIMENSION B DOES NOT INCLUDE INTERLEAD FLASH OR PROTRUSION. INTERLEAD FLASH OR PROTRUSION SHALL NOT EXCEED 0.25 (0.010) PER SIDE.
5. DIMENSION K DOES NOT INCLUDE DAMBAR PROTRUSION. ALLOWABLE DAMBAR PROTRUSION SHALL BE 0.08 (0.003) TOTAL IN EXCESS OF THE K DIMENSION AT MAXIMUM MATERIAL CONDITION.
6. TERMINAL NUMBERS ARE SHOWN FOR REFERENCE ONLY.
7. DIMENSION A AND B ARE TO BE DETERMINED AT DATUM PLANE -W-.

DIM	MILLIMETERS		INCHES	
	MIN	MAX	MIN	MAX
A	4.90	5.10	0.193	0.200
B	4.30	4.50	0.169	0.177
C	---	1.20	---	0.047
D	0.05	0.15	0.002	0.006
F	0.50	0.75	0.020	0.030
G	0.65 BSC		0.026 BSC	
H	0.18	0.28	0.007	0.011
J	0.09	0.20	0.004	0.008
J1	0.09	0.16	0.004	0.006
K	0.19	0.30	0.007	0.012
K1	0.19	0.25	0.007	0.010
L	6.40 BSC		0.252 BSC	
M	0°	8°	0°	8°

MC74HC4046A

PACKAGE DIMENSIONS

SOEIAJ-16
F SUFFIX
CASE 966-01
ISSUE O

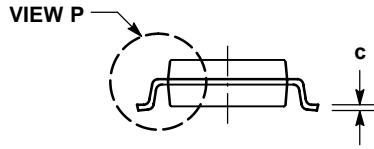
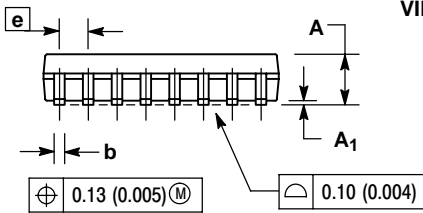
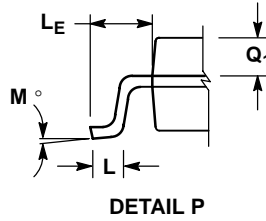
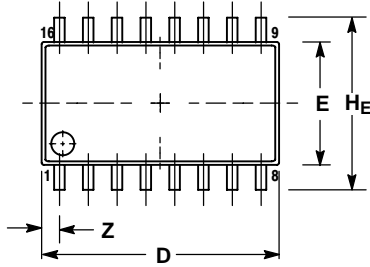

NOTES:

1. DIMENSIONING AND TOLERANCING PER ANSI Y14.5M, 1982.
2. CONTROLLING DIMENSION: MILLIMETER.
3. DIMENSIONS D AND E DO NOT INCLUDE MOLD FLASH OR PROTRUSIONS AND ARE MEASURED AT THE PARTING LINE. MOLD FLASH OR PROTRUSIONS SHALL NOT EXCEED 0.15 (0.006) PER SIDE.
4. TERMINAL NUMBERS ARE SHOWN FOR REFERENCE ONLY.
5. THE LEAD WIDTH DIMENSION (b) DOES NOT INCLUDE DAMBAR PROTRUSION. ALLOWABLE DAMBAR PROTRUSION SHALL BE 0.08 (0.003) TOTAL IN EXCESS OF THE LEAD WIDTH DIMENSION AT MAXIMUM MATERIAL CONDITION. DAMBAR CANNOT BE LOCATED ON THE LOWER RADIUS OR THE FOOT. MINIMUM SPACE BETWEEN PROTRUSIONS AND ADJACENT LEAD TO BE 0.46 (0.018).

DIM	MILLIMETERS		INCHES	
	MIN	MAX	MIN	MAX
A	---	2.05	---	0.081
A ₁	0.05	0.20	0.002	0.008
b	0.35	0.50	0.014	0.020
c	0.18	0.27	0.007	0.011
D	9.90	10.50	0.390	0.413
E	5.10	5.45	0.201	0.215
e	1.27 BSC		0.050 BSC	
H _E	7.40	8.20	0.291	0.323
L	0.50	0.85	0.020	0.033
L _E	1.10	1.50	0.043	0.059
M	0°	10°	0°	10°
Q ₁	0.70	0.90	0.028	0.035
Z	---	0.78	---	0.031

MC74HC4046A

ON Semiconductor and **ON** are registered trademarks of Semiconductor Components Industries, LLC (SCILLC). SCILLC reserves the right to make changes without further notice to any products herein. SCILLC makes no warranty, representation or guarantee regarding the suitability of its products for any particular purpose, nor does SCILLC assume any liability arising out of the application or use of any product or circuit, and specifically disclaims any and all liability, including without limitation special, consequential or incidental damages. "Typical" parameters which may be provided in SCILLC data sheets and/or specifications can and do vary in different applications and actual performance may vary over time. All operating parameters, including "Typicals" must be validated for each customer application by customer's technical experts. SCILLC does not convey any license under its patent rights nor the rights of others. SCILLC products are not designed, intended, or authorized for use as components in systems intended for surgical implant into the body, or other applications intended to support or sustain life, or for any other application in which the failure of the SCILLC product could create a situation where personal injury or death may occur. Should Buyer purchase or use SCILLC products for any such unintended or unauthorized application, Buyer shall indemnify and hold SCILLC and its officers, employees, subsidiaries, affiliates, and distributors harmless against all claims, costs, damages, and expenses, and reasonable attorney fees arising out of, directly or indirectly, any claim of personal injury or death associated with such unintended or unauthorized use, even if such claim alleges that SCILLC was negligent regarding the design or manufacture of the part. SCILLC is an Equal Opportunity/Affirmative Action Employer. This literature is subject to all applicable copyright laws and is not for resale in any manner.

PUBLICATION ORDERING INFORMATION

LITERATURE FULFILLMENT:

Literature Distribution Center for ON Semiconductor
P.O. Box 61312, Phoenix, Arizona 85082-1312 USA

Phone: 480-829-7710 or 800-344-3860 Toll Free USA/Canada

Fax: 480-829-7709 or 800-344-3867 Toll Free USA/Canada

Email: orderlit@onsemi.com

N. American Technical Support: 800-282-9855 Toll Free
USA/Canada

Japan: ON Semiconductor, Japan Customer Focus Center
2-9-1 Kamimeguro, Meguro-ku, Tokyo, Japan 153-0051

Phone: 81-3-5773-3850

ON Semiconductor Website: <http://onsemi.com>

Order Literature: <http://www.onsemi.com/litorder>

For additional information, please contact your
local Sales Representative.

MC74HC4046A/D